



*Productivity Through*  
**Comfort**

**Maximum Efficiency Evaporative Air Cooling**

To meet today's growing demand for increased productivity and serviceability, PMI has designed and offers the AeroCool Commercial Cooler to provide high efficiency in evaporative cooling.

**Economical and Dependable Cooling**

U.L. Listed Models  
also available



# Powerful Cooling Maximum Efficiency

Whether used to cool an entire facility or simply to spot-cool specific areas, the AeroCool Commercial Rigid Media Cooler can supplement and/or replace mechanical refrigeration needs. The AeroCool Series is an ideal cooling solution for commercial, industrial, institutional or agricultural facilities and buildings that require moving large quantities of fresh air. Laundries, gymnasiums, kitchens, heat-treating areas and dry cleaning plants are perfect candidates for energy efficient evaporative cooling.

- Perfect for buildings that require large quantities of fresh air.
- Uses highly efficient rigid media.
- Proven alternative to costly mechanical refrigeration systems.
- Constructed of heavy galvanized steel.
- Available in side draft, down draft and updraft configurations.
- Belt included with dry section.
- Metal skids under each module for roof mounting. Lift brackets are supplied for lifting to installation site.
- Knockout for electrical service is 7/8".
- Water supply line is 1/4" O.D. and service can be from either side.

## Configured to Meet Your Application

We provide a large array of configurations; single and dual wet section models, from 3/4 to 10 horsepower motors and multiple CFM outputs. All sizes of the AeroCool Industrial series are available in side or down draft configurations. In addition, the IUP 701 and IUP 800

up-discharge units are designed for specialized installations or access needs. All these options combine to create an industry-leading level of configuration options allowing you to facilitate the most energy efficient cooler for your specific application.



Down Single Inlet



Side Single Inlet



Down Dual Inlet



Side Dual Inlet



Up Dual Inlet

## Sizing Procedures

Use the appropriate Air Delivery performance tables and the procedure to the right to properly size these AeroCool Commercial units.

**8" Media coolers** - pages 4-5

**12" Media coolers** - pages 6-7

**4x4 Media coolers** - pages 8-9

The performance or Sensible Heat Capacity of any evaporative cooler is a function of both the CFM and the efficiency (air discharge temperature). Both of these specifications should be considered to properly size the units.

Static pressure, or duct system resistance, also impacts air delivery. Once the model number, CFM air delivery required and static pressure are known, identify the blower wheel RPM in the column to the right of CFM air delivery. This will ensure a properly sized sheave.

1. Determine design Conditions
  - Outside Dry-Bulb (DB)
  - Outside Wet-Bulb (WB)
  - Inside Dry-Bulb (TI)
2. Determine the design Sensible Heat Load. (Btuh)

Determine the Cooler Leaving Air Temperature (LAT)

$$LAT = DB - [(DB - WB) EFF]$$

8" Media - EFF ≈ .85

12" Media - EFF ≈ .90

4x4 Media - EFF ≈ .93

3. Determine the CFM required
 
$$CFM = \frac{0.925 \times \text{Sensible Heat Load}}{(TI - LAT)}$$
4. Determine the cooler(s) required by referring to the appropriate air flow charts on pages 4, 6 and 8.



See complete marking on product

### UL Classified Models

The AeroCool Commercial models are UL Classified. In order to maintain this U.L. Classified designation, these models must be used in conjunction with PMI supplied Motors, Sheaves, Pumps and Junction Box kits (JBK).



### UL Listed Models

U.L. listed models also available. To specify and order a U.L. Listed model, add a "U" prefix to the front of the appropriate model number.

**Example:**  
**UID601 & UWS100**



## Built to Last

AeroCool Industrial coolers are constructed of heavy galvanized steel. Each component is then coated with our exclusive multi-layer Peblar XT finish, developed to protect the structure and help it resist rust and corrosion.

The industrial size blower wheel is dynamically balanced and paired with long-life ball bearings to ensure trouble free operation.

The AeroCool series will provide years of reliable service and provide maximum return on your investment.

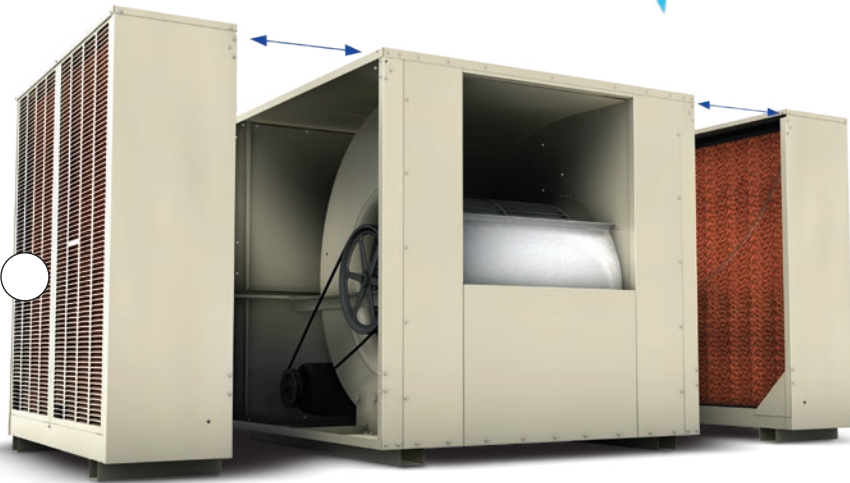
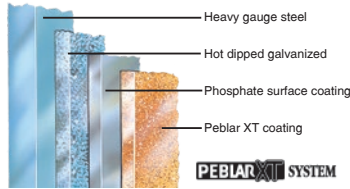

## Modular Wet Sections

The AeroCool Industrial coolers can be equipped with wet sections that have 8" or 12" rigid media or the hi-efficient 4x4 media for maximum cooling power.

This rigid media is constructed of special cellulose material, impregnated with insoluble decay resistant chemicals as well as rigidifying saturants. The unique design of the pads, which continually direct water to the air inlet side, induces highly turbulent mixing of air and water for optimum moisture transfer. This process results in cooler, consistent air flow with lower temperatures.



### Good 8" Rigid Media

- Economical choice
- Lower Replacement Cost



### Better 12" Rigid Media

- Higher efficiency
- More surface area for better cooling



### Best 4x4 Rigid Media

- Highest efficiency, offers the best cooling
- Uses Hi-Density media

*Each wet section can be configured with 8", 12" or Hi-Density 4x4 rigid media*



## Simplify & Save

Simplify and save on your next industrial/commercial evaporative cooler installation job. Phoenix Manufacturing brings the highest level of customer service possible by offering factory assembly and pre-wire services that save both time and money on all your installation jobs.

**Factory Assembled**

**Factory Wired**

**Factory Tested**

**SPC**

Single Point Connection

**FAC**

Factory Assembled Cooler

*Ask your PMI dealer about Single Point Connection and Factory Assembly services by PMI.*

# 8" Standard Media

Economical choice - Lower Replacement Cost



Phoenix Manufacturing, Inc. certifies that the evaporative coolers shown are licensed to bear the AMCA seal. The ratings shown are based on tests and procedures performed in accordance with AMCA publication 211 and comply with the requirements of the AMCA Certified Ratings Program.

Specification of critical components is vital in obtaining the required discharge volume through the unit. Motor horsepower, voltage, motor shaft outside diameter, motor sheave outside and inside diameter all directly relate to the revolutions per minute (RPM) of the blower wheel. Equally important is the reduction in electrical usage and water required for operation.

Performance certified is for installation Type B - free inlet, ducted outlet. Power Rating (B.H.P.) does not include transmission losses. Performance ratings include the effects of evaporative media.

## Standard 8" Wet Sections

Certified Air Delivery at Various External Static Pressures

- Blower RPM values based on motor RPM 1725  
- AMCA Licensed

		External Static Pressure - inches H2O																						
ID500		0"		.1"		.2"		.3"		.4"		.5"		.6"		.7"		.8"		.9"		1.0"		
CFM UP TO 9,875	Wet Section	HP	CFM	RPM	CFM	RPM	CFM	RPM	CFM	RPM	CFM	RPM	CFM	RPM	CFM	RPM	CFM	RPM	CFM	RPM	CFM	RPM		
	WS080	3/4	6,700	295	6,250	310	5,850	325	5,400	337	5,000	350	4,500	363	3,800	380	3,200	409	2,975	430	2,550	452	2,200	475
		1	7,350	325	6,950	338	6,625	352	6,200	364	5,800	375	5,425	387	5,000	400	4,500	413	3,650	440	3,375	460	3,050	479
		1 1/2	8,425	371	8,075	384	7,775	396	7,450	408	7,075	417	6,700	427	6,400	437	6,050	447	5,650	458	5,200	471	4,350	495
		2	9,275	410	8,950	420	8,675	432	8,400	442	8,100	451	7,725	460	7,400	469	7,125	478	6,800	488	6,450	497	6,100	507
3	9,875	435	9,875	460	9,875	480	9,825	497	9,600	507	9,325	515	9,025	523	8,725	530	8,450	538	8,200	546	7,950	554		

		External Static Pressure - inches H2O																						
IS500		0"		.1"		.2"		.3"		.4"		.5"		.6"		.7"		.8"		.9"		1.0"		
CFM UP TO 9,875	Wet Section	HP	CFM	RPM	CFM	RPM	CFM	RPM	CFM	RPM	CFM	RPM	CFM	RPM	CFM	RPM	CFM	RPM	CFM	RPM	CFM	RPM		
	WS080	3/4	6,825	291	6,450	302	6,050	314	5,675	325	5,250	338	4,825	358	3,950	380	3,350	400	2,900	425	2,400	455	1,950	480
		1	7,525	320	7,200	330	6,825	341	6,450	352	6,125	363	5,700	375	5,050	392	4,400	414	3,925	431	3,500	452	3,050	476
		1 1/2	8,600	368	8,325	375	8,000	385	7,675	395	7,375	404	7,100	413	6,750	423	6,325	434	5,650	454	5,100	472	4,700	485
		2	9,500	405	9,225	412	8,950	420	8,650	428	8,325	437	8,075	445	7,800	454	7,500	463	7,150	472	6,700	484	6,000	508
3	9,875	420	9,875	439	9,875	455	9,875	473	9,875	491	9,600	498	9,350	507	9,150	514	8,900	522	8,650	529	8,350	537		

		External Static Pressure - inches H2O																						
ID/IS601		0"		.1"		.2"		.3"		.4"		.5"		.6"		.7"		.8"		.9"		1.0"		
CFM UP TO 17,100	Wet Section	HP	CFM	RPM	CFM	RPM	CFM	RPM	CFM	RPM	CFM	RPM	CFM	RPM	CFM	RPM	CFM	RPM	CFM	RPM	CFM	RPM		
	WS080	1	8,725	255	8,275	268	7,775	282	7,300	295	6,825	310	6,350	326	5,850	342	5,300	360	4,700	383	4,050	418	3,475	446
		1 1/2	10,000	292	9,625	304	9,200	315	8,750	327	8,325	339	7,900	352	7,475	366	7,075	379	6,625	393	6,150	409	5,650	428
		2	11,000	321	10,675	332	10,275	342	9,875	353	9,500	364	9,125	375	8,700	387	8,350	399	7,975	412	7,575	423	7,175	436
		3	12,600	369	12,300	378	11,975	386	11,650	395	11,300	404	10,950	413	10,600	424	10,275	434	9,925	445	9,600	456	9,275	466
		5	14,950	438	14,700	445	14,425	452	14,150	460	13,875	468	13,575	474	13,275	482	12,975	490	12,700	499	12,400	506	12,125	516
		7 1/2	17,100	500	16,800	507	16,675	514	16,425	520	16,200	526	15,925	532	15,675	540	15,425	546	15,150	553	14,900	560	14,650	568

		External Static Pressure - inches H2O																						
ID/IS/IUP701		0"		.1"		.2"		.3"		.4"		.5"		.6"		.7"		.8"		.9"		1.0"		
CFM UP TO 19,750	Wet Section	HP	CFM	RPM	CFM	RPM	CFM	RPM	CFM	RPM	CFM	RPM	CFM	RPM	CFM	RPM	CFM	RPM	CFM	RPM	CFM	RPM		
	WS080	1	10,650	197	9,950	214	9,175	226	8,475	242	7,825	259	7,075	277	5,400	315	3,975	343	3,475	365	3,125	385	2,850	403
		1 1/2	12,200	226	11,650	241	10,900	251	10,250	264	9,675	278	9,100	293	8,500	306	7,700	325	5,800	368	4,675	390	4,175	410
		2	13,450	249	12,950	262	12,300	272	11,650	282	11,075	295	10,550	309	10,050	322	9,500	332	8,875	348	7,875	369	5,850	410
		3	15,400	285	14,950	298	14,500	308	13,850	314	13,300	324	12,800	335	12,350	347	11,875	358	11,425	370	10,975	380	10,425	391
		5	18,250	338	17,900	350	17,500	359	17,025	366	16,550	372	16,050	380	15,600	388	15,200	397	14,800	407	14,425	416	14,025	426
		7 1/2	19,750	366	19,750	382	19,750	397	19,750	411	19,475	420	19,050	425	18,600	431	18,200	438	17,800	446	17,450	454	17,000	462
10	OPERATION NOT RECOMMENDED IN THIS AREA, WATER ENTRAINMENT WILL OCCUR.										19,750	424	19,750	436	19,750	449	19,750	461	19,750	472	19,750	485	19,500	493

		External Static Pressure - inches H2O																						
ID/IS/IUP800		0"		.1"		.2"		.3"		.4"		.5"		.6"		.7"		.8"		.9"		1.0"		
CFM UP TO 25,750	Wet Section	HP	CFM	RPM	CFM	RPM	CFM	RPM	CFM	RPM	CFM	RPM	CFM	RPM	CFM	RPM	CFM	RPM	CFM	RPM	CFM	RPM		
	WS880	2	15,000	232	14,400	241	13,700	250	13,000	259	12,400	269	11,700	278	10,900	288	10,200	297	9,200	309	8,600	325	7,000	360
		3	17,200	266	16,600	274	16,100	282	15,500	289	14,900	298	14,400	306	13,700	313	13,100	322	12,400	330	11,800	343	11,200	348
		5	20,400	315	19,900	322	19,500	328	18,900	335	18,500	342	17,900	348	17,500	355	17,000	362	16,500	368	15,900	375	15,400	382
		7 1/2	23,400	361	23,000	367	22,600	373	22,100	378	21,700	384	21,200	390	20,800	395	20,400	402	20,000	407	19,600	413	19,100	420
		10	25,750	397	25,400	403	25,000	407	24,600	413	24,200	418	23,800	423	23,400	428	23,000	434	22,600	438	22,200	444	21,900	450

Do not exceed listed rpm, motor current draw (FLA) will be less than nameplate. Water entrainment may occur if operated at higher rpm's than indicated.

Operation in high static pressure - low CFM conditions can lead to motor RPM fluctuation

# 8" Standard Media

ID500 w/ WS080 - Airflow Data

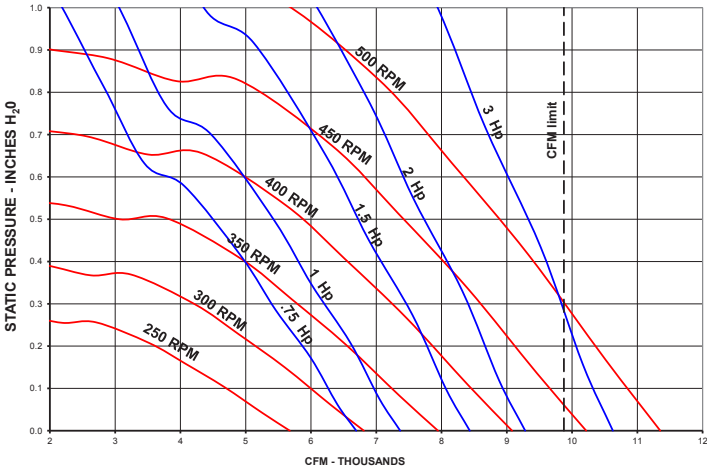

IS500 w/ WS080 - Airflow Data

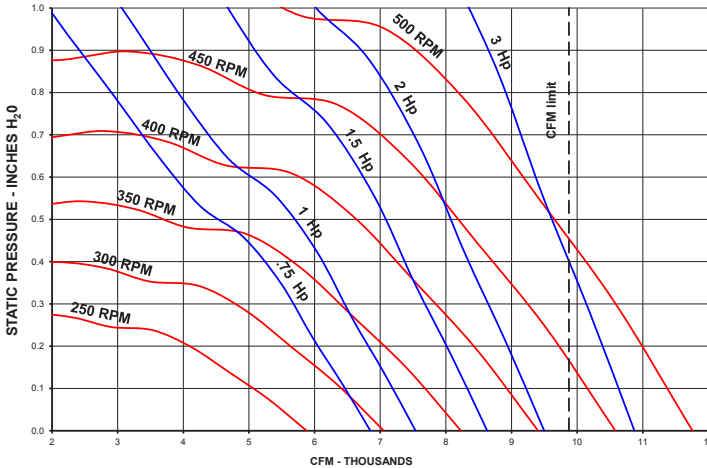

ID/IS601 w/ WS080 - Airflow Data

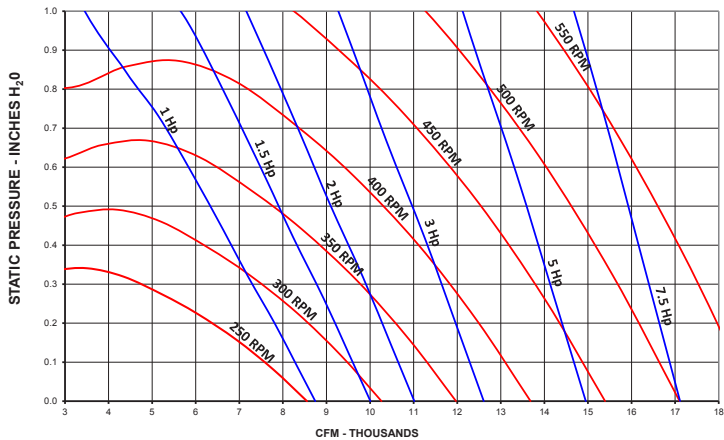

ID/IS/IUP701 w/ WS080 - Airflow Data

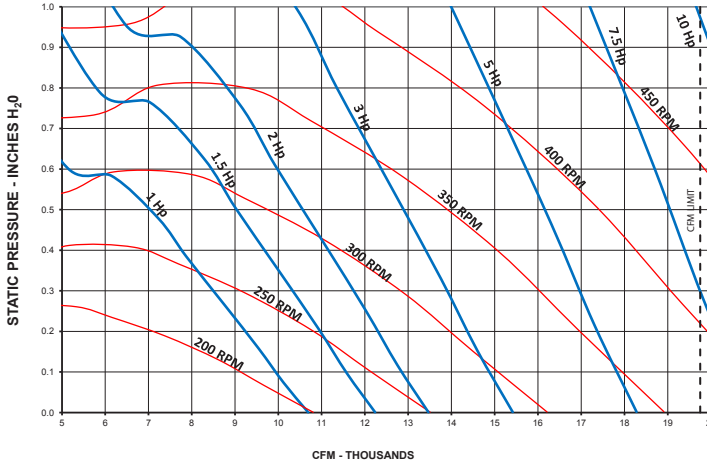

ID/IS/IUP800 w/ WS880 - Airflow Data

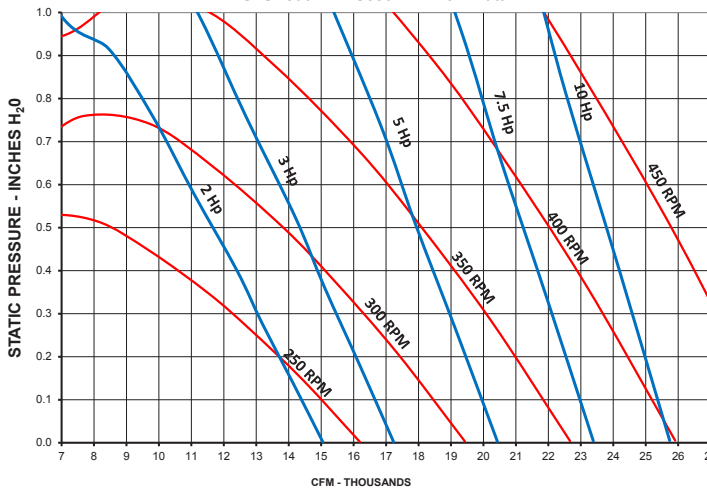

# 12" Standard Media

High efficiency - More surface area for better cooling



Phoenix Manufacturing, Inc. certifies that the evaporative coolers shown are licensed to bear the AMCA seal. The ratings shown are based on tests and procedures performed in accordance with AMCA publication 211 and comply with the requirements of the AMCA Certified Ratings Program.

Specification of critical components is vital in obtaining the required discharge volume through the unit. Motor horsepower, voltage, motor shaft outside diameter, motor sheave outside and inside diameter all directly relate to the revolutions per minute (RPM) of the blower wheel. Equally important is the reduction in electrical usage and water required for operation.

Performance certified is for installation Type B - free inlet, ducted outlet. Power Rating (B.H.P.) does not include transmission losses. Performance ratings include the effects of evaporative media.

## Standard 12" Wet Sections

Certified Air Delivery at Various External Static Pressures

- Blower RPM values based on motor RPM 1725  
- AMCA Licensed

		External Static Pressure - inches H2O																								
ID500		0"		.1"		.2"		.3"		.4"		.5"		.6"		.7"		.8"		.9"		1.0"				
CFM UP TO 9,875	Wet Section	HP	CFM	RPM	CFM	RPM	CFM	RPM	CFM	RPM	CFM	RPM	CFM	RPM	CFM	RPM	CFM	RPM	CFM	RPM	CFM	RPM	CFM	RPM		
		3/4	6,700	275	6,325	294	5,925	307	5,500	320	5,125	333	4,775	348	3,900	380	3,250	400	2,800	418	2,400	443	2,000	465		
		1	7,350	304	7,050	320	6,675	332	6,300	344	5,925	356	5,575	368	5,250	382	4,850	400	3,800	434	3,375	448	2,975	469		
		1 1/2	8,425	348	8,150	362	7,850	375	7,525	385	7,200	395	6,850	405	6,550	416	6,275	427	6,000	439	5,650	452	4,600	490		
		2	9,275	384	9,050	396	8,750	407	8,475	417	8,175	427	7,850	436	7,550	445	7,300	455	7,025	465	6,750	476	6,500	487		
		3	9,875	406	9,875	429	9,875	450	9,875	467	9,675	478	9,350	487	9,150	495	8,875	502	8,625	510	8,375	520	8,150	528		

		External Static Pressure - inches H2O																								
IS500		0"		.1"		.2"		.3"		.4"		.5"		.6"		.7"		.8"		.9"		1.0"				
CFM UP TO 9,875	Wet Section	HP	CFM	RPM	CFM	RPM	CFM	RPM	CFM	RPM	CFM	RPM	CFM	RPM	CFM	RPM	CFM	RPM	CFM	RPM	CFM	RPM	CFM	RPM		
		3/4	6,725	281	6,350	295	5,900	307	5,475	320	5,050	334	4,200	360	3,700	377	3,375	393	2,950	415	2,350	447	1,800	476		
		1	7,400	310	7,050	322	6,650	334	6,300	345	5,875	357	5,450	365	4,550	397	4,175	411	3,850	426	3,550	442	3,100	465		
		1 1/2	8,500	354	8,175	365	7,850	376	7,525	386	7,175	396	6,800	406	6,475	417	6,050	429	5,250	457	4,850	468	4,525	480		
		2	9,250	390	9,075	400	8,775	409	8,450	418	8,150	428	7,850	437	7,500	447	7,200	457	6,975	467	6,150	489	5,650	507		
		3	9,875	410	9,875	432	9,875	450	9,875	470	9,675	480	9,400	489	9,125	496	8,850	504	8,550	513	8,300	521	8,000	530		

		External Static Pressure - inches H2O																								
ID/IS601		0"		.1"		.2"		.3"		.4"		.5"		.6"		.7"		.8"		.9"		1.0"				
CFM UP TO 16,875	Wet Section	HP	CFM	RPM	CFM	RPM	CFM	RPM	CFM	RPM	CFM	RPM	CFM	RPM	CFM	RPM	CFM	RPM	CFM	RPM	CFM	RPM	CFM	RPM		
		1	8,625	262	8,150	275	7,675	290	7,175	305	6,700	318	6,225	332	5,725	346	5,200	365	4,500	392	3,800	422	3,400	444		
		1 1/2	9,850	300	9,475	312	9,050	323	8,600	337	8,175	350	7,750	362	7,350	373	6,925	386	6,500	399	6,050	415	5,500	432		
		2	10,850	330	10,500	340	10,125	352	9,725	362	9,325	375	8,925	387	8,550	398	8,175	408	7,825	419	7,425	431	7,025	442		
		3	12,425	378	12,125	386	11,800	396	11,450	406	11,100	417	10,750	427	10,400	438	10,075	448	9,750	456	9,450	465	9,100	475		
		5	14,750	447	14,475	455	14,200	463	13,925	471	13,650	480	13,350	488	13,050	497	12,750	506	12,475	515	12,200	523	11,900	531		
		7 1/2	16,875	511	16,650	519	16,400	526	16,175	532	15,950	540	15,675	547	15,425	555	15,175	562	14,900	570	14,650	577	14,400	585		

		External Static Pressure - inches H2O																								
ID/IS/IUP701		0"		.1"		.2"		.3"		.4"		.5"		.6"		.7"		.8"		.9"		1.0"				
CFM UP TO 19,750	Wet Section	HP	CFM	RPM	CFM	RPM	CFM	RPM	CFM	RPM	CFM	RPM	CFM	RPM	CFM	RPM	CFM	RPM	CFM	RPM	CFM	RPM	CFM	RPM		
		1	10,100	206	9,450	219	8,800	231	8,100	248	7,400	262	6,700	280	4,900	314	4,200	333	3,700	354	3,100	374	2,450	392		
		1 1/2	11,600	235	11,000	248	10,450	258	9,850	270	9,225	284	8,600	297	8,050	311	7,450	334	6,850	362	6,250	389	4,350	396		
		2	12,750	259	12,250	270	11,700	280	11,200	290	10,600	302	10,050	314	9,500	327	9,000	339	8,400	353	7,800	379	7,350	403		
		3	14,650	296	14,150	305	13,700	315	13,250	322	12,800	332	12,275	344	11,800	354	11,300	364	10,825	375	10,375	386	9,950	398		
		5	17,350	350	16,950	359	16,550	366	16,150	373	15,750	382	15,400	390	14,950	398	14,550	407	14,150	416	13,750	425	13,350	434		
		7 1/2	19,750	402	19,500	409	19,150	416	18,800	422	18,475	429	18,150	435	17,800	442	17,475	449	17,100	456	16,750	465	16,400	472		
		10	19,750	402	19,750	417	19,750	430	19,750	442	19,750	451	19,750	465	19,750	470	19,750	478	19,375	485	19,050	498	18,750	505		

		External Static Pressure - inches H2O																								
ID/IS/IUP800		0"		.1"		.2"		.3"		.4"		.5"		.6"		.7"		.8"		.9"		1.0"				
CFM UP TO 25,500	Wet Section	HP	CFM	RPM	CFM	RPM	CFM	RPM	CFM	RPM	CFM	RPM	CFM	RPM	CFM	RPM	CFM	RPM	CFM	RPM	CFM	RPM	CFM	RPM		
		2	14,800	232	14,200	241	13,500	250	12,800	257	12,200	268	11,500	278	10,900	288	10,100	299	9,100	312	8,200	328	6,500	360		
		3	17,000	265	16,400	274	15,800	281	15,300	288	14,700	296	14,100	305	13,500	313	12,900	321	12,400	330	11,600	340	10,900	351		
		5	20,200	315	19,700	322	19,200	328	18,700	335	18,200	341	17,700	347	17,200	354	16,700	361	16,200	368	15,800	375	15,300	382		
		7 1/2	23,100	362	22,700	367	22,200	372	21,700	378	21,400	383	20,900	388	20,500	394	20,100	400	19,600	408	19,200	412	18,800	418		
		10	25,500	398	25,100	403	24,700	408	24,300	413	23,800	417	23,400	422	23,100	428	22,700	433	22,300	438	21,900	443	21,500	448		

Do not exceed listed rpm, motor current draw (FLA) will be less than nameplate. Water entrainment may occur if operated at higher rpm's than indicated.

Operation in high static pressure - low CFM conditions can lead to motor RPM fluctuation



# 12" Standard Media

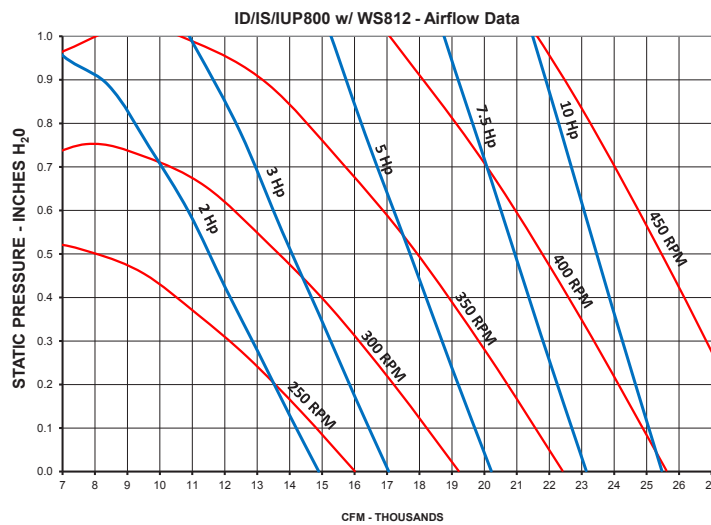
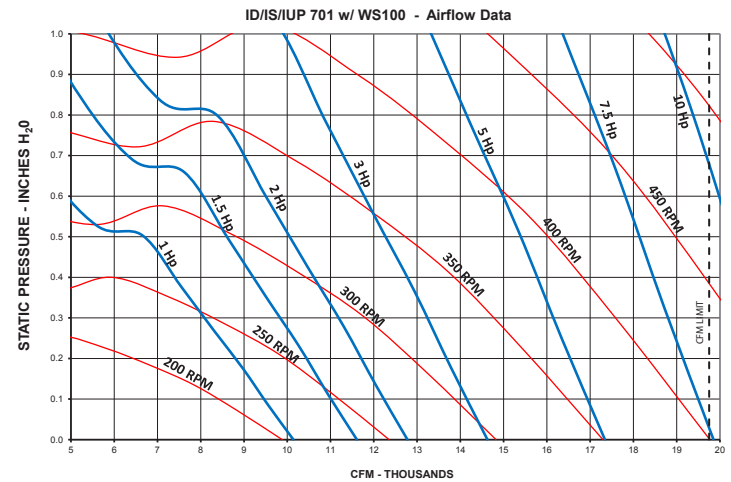
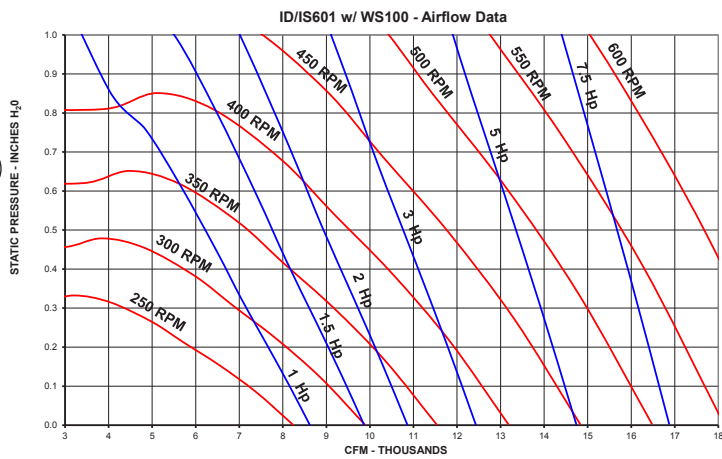
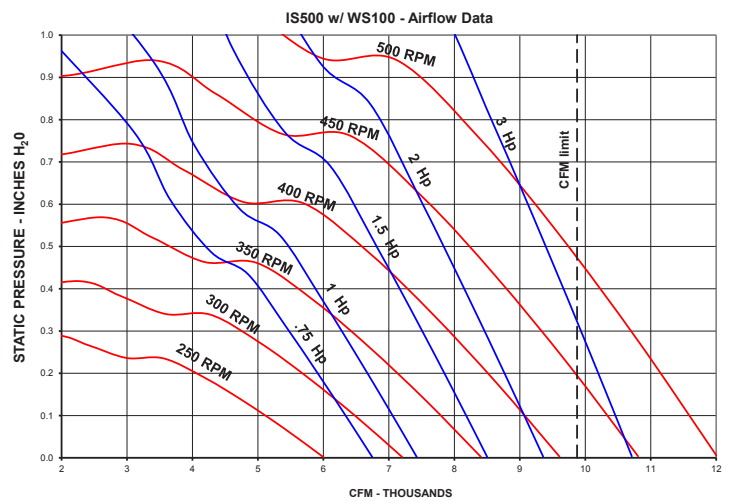
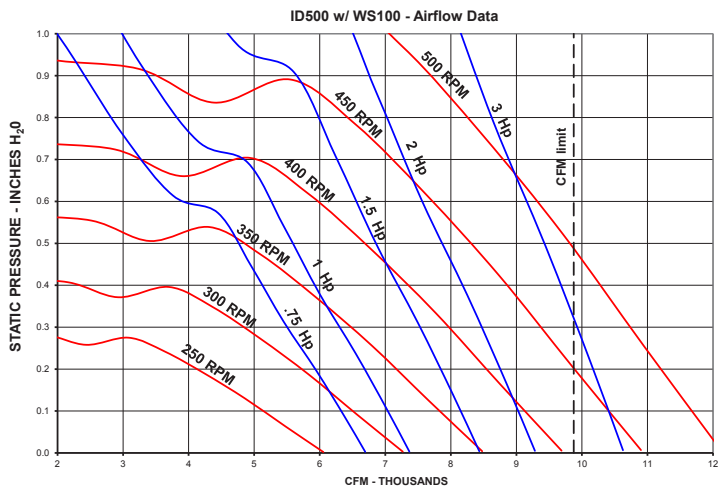

# 4x4 Hi-Density Media

Highest efficiency provides for the most cooling

Specification of critical components is vital in obtaining the required discharge volume through the unit. Motor horsepower, voltage, motor shaft outside diameter, motor sheave outside and inside diameter all directly relate to the revolutions per minute (RPM) of the blower wheel. Equally important is the reduction in electrical usage and water required for operation.

Performance data is for installation Type B - free inlet, ducted outlet. Power Rating (B.H.P.) for the ID/IS/IUP800 with Wet Section WS844 does not include transmission losses. Performance ratings include the effects of evaporative media.

**Power Rating (B.H.P.) DOES Include Transmission Losses**

## Ultra-efficient 4x4 Wet Sections

- Blower RPM values based on motor RPM 1725

Air Delivery at Various External Static Pressures

		External Static Pressure - inches H2O																							
		0"		.1"		.2"		.3"		.4"		.5"		.6"		.7"		.8"		.9"		1.0"			
CFM UP TO 9,100	<b>ID500</b>	Wet Section	HP	CFM	RPM	CFM	RPM	CFM	RPM	CFM	RPM	CFM	RPM	CFM	RPM	CFM	RPM	CFM	RPM	CFM	RPM	CFM	RPM		
			3/4	5,900	292	5,400	310	4,900	322	4,450	334	3,900	350	3,350	376	2,650	403	1,950	429	1,450	453	1,050	478		
			1	6,550	322	6,050	340	5,600	350	5,150	360	4,700	375	4,250	390	3,700	413	3,100	438	2,450	462	1,850	485	1,450	505
			1 1/2	7,500	370	7,050	385	6,600	395	6,250	405	5,900	412	5,500	420	5,100	435	4,650	453	4,200	475	3,650	496	3,050	518
			2	8,250	405	7,800	420	7,450	430	7,100	440	6,750	448	6,400	455	6,100	462	5,700	475	5,350	490	4,900	510	4,450	530
		3	9,400	465	9,050	478	8,700	490	8,400	495	8,100	503	7,800	510	7,500	518	7,200	525	6,900	532	6,600	542	6,250	555	
CFM UP TO 9,750	<b>IS500</b>	Wet Section	HP	CFM	RPM	CFM	RPM	CFM	RPM	CFM	RPM	CFM	RPM	CFM	RPM	CFM	RPM	CFM	RPM	CFM	RPM	CFM	RPM		
			3/4	6,150	290	5,700	298	5,200	314	4,600	332	3,950	355	3,250	380	2,550	405	1,900	425	1,250	446	750	465	300	482
			1	6,750	316	6,350	325	5,900	340	5,400	355	4,850	374	4,250	395	3,600	418	2,950	438	2,350	460	1,800	480	1,250	495
			1 1/2	7,750	360	7,400	370	7,000	380	6,600	393	6,150	406	5,700	422	5,150	442	4,600	460	4,050	480	3,500	500	2,950	518
			2	8,500	400	8,200	405	7,900	415	7,500	425	7,100	438	6,700	450	6,300	465	5,800	481	5,350	498	4,800	516	4,300	534
		3	9,750	455	9,500	462	9,200	470	8,900	478	8,600	486	8,250	496	7,900	509	7,500	520	7,150	535	6,750	548	6,300	562	
CFM UP TO 15,300	<b>ID/IS601</b>	Wet Section	HP	CFM	RPM	CFM	RPM	CFM	RPM	CFM	RPM	CFM	RPM	CFM	RPM	CFM	RPM	CFM	RPM	CFM	RPM	CFM	RPM		
			1	7,800	271	7,300	286	6,800	300	6,250	314	5,700	330	5,100	346	4,450	365	3,850	385	3,200	408	2,550	432	1,850	458
			1 1/2	8,900	311	8,500	325	8,100	336	7,600	350	7,100	362	6,650	374	6,100	386	5,600	403	5,050	420	4,500	438	3,950	456
			2	9,850	341	9,450	355	9,050	368	8,650	378	8,200	388	7,800	398	7,300	410	6,850	423	6,400	436	5,900	452	5,400	465
			3	11,300	392	10,900	404	10,600	414	10,200	423	9,900	432	9,500	441	9,100	451	8,700	461	8,300	471	7,900	482	7,500	493
			5	13,400	465	13,100	475	12,800	483	12,500	492	12,200	500	11,900	508	11,600	515	11,250	524	10,900	532	10,600	540	10,300	548
		7 1/2	15,300	532	15,100	540	14,800	550	14,550	558	14,250	565	14,000	570	13,750	578	13,500	584	13,200	592	12,950	598	12,700	605	
CFM UP TO 19,750	<b>ID/ISIUP701</b>	Wet Section	HP	CFM	RPM	CFM	RPM	CFM	RPM	CFM	RPM	CFM	RPM	CFM	RPM	CFM	RPM	CFM	RPM	CFM	RPM	CFM	RPM		
			1	9,200	206	8,500	226	7,800	242	6,850	260	5,700	282	4,400	313	3,200	349								
			1 1/2	10,500	236	10,000	255	9,350	270	8,600	282	7,800	297	6,800	318	5,700	342	4,500	373	3,500	402				
			2	11,600	259	11,100	276	10,550	291	9,900	303	9,250	316	8,450	330	7,500	347	6,500	371	5,500	398	4,500	425	3,600	450
			3	13,250	297	12,850	313	12,400	327	11,900	338	11,350	348	10,750	360	10,050	372	9,300	384	8,500	402	7,650	421	6,700	443
			5	15,750	351	15,400	367	15,000	378	14,600	389	14,200	398	13,750	408	13,250	417	12,750	426	12,150	435	11,600	446	10,950	457
		7 1/2	18,000	402	17,750	416	17,400	427	17,050	437	16,700	446	16,300	454	15,950	462	15,550	470	15,100	477	14,650	485	14,200	494	
		10	19,750	443	19,550	455	19,250	466	18,950	475	18,650	484	18,350	492	18,000	500	17,650	506	17,300	513	16,900	521	16,500	529	

**Power Rating (B.H.P.) DOES NOT Include Transmission Losses**

		External Static Pressure - inches H2O																							
		0"		.1"		.2"		.3"		.4"		.5"		.6"		.7"		.8"		.9"		1.0"			
CFM UP TO 24,900	<b>ID/IS/IUP800</b>	Wet Section	HP	CFM	RPM	CFM	RPM	CFM	RPM	CFM	RPM	CFM	RPM	CFM	RPM	CFM	RPM	CFM	RPM	CFM	RPM	CFM	RPM		
			2	14,500	234	13,850	242	13,150	251	12,450	261	11,800	270	11,200	280	10,400	290	9,600	301	8,700	316	7,800	335	6,900	360
			3	16,650	267	16,100	275	15,450	283	14,850	291	14,250	299	13,650	307	13,050	315	12,450	325	11,800	334	11,150	343	10,400	355
			5	19,750	317	19,250	323	18,750	330	18,250	336	17,750	343	17,200	350	16,700	357	16,200	363	15,700	372	15,200	378	14,700	386
			7 1/2	22,600	362	22,150	368	21,750	374	21,300	380	20,850	385	20,400	392	19,950	397	19,500	404	19,050	410	18,600	416	18,200	422
		10	24,900	398	24,500	404	24,100	409	23,700	414	23,300	420	22,900	425	22,450	431	22,050	436	21,650	442	21,250	447	20,850	452	

Operation in high static pressure - low CFM conditions can lead to motor RPM fluctuation



# 4x4 Hi-Density Media

ID500 w/ WS144 - Airflow Data

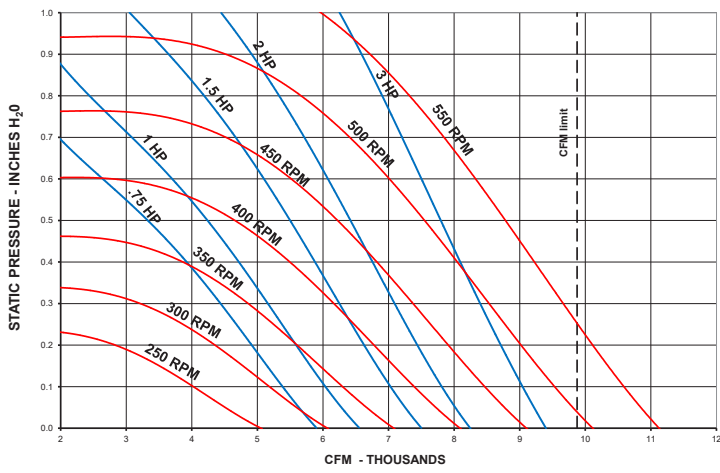

IS500 w/ WS144 - Airflow Data

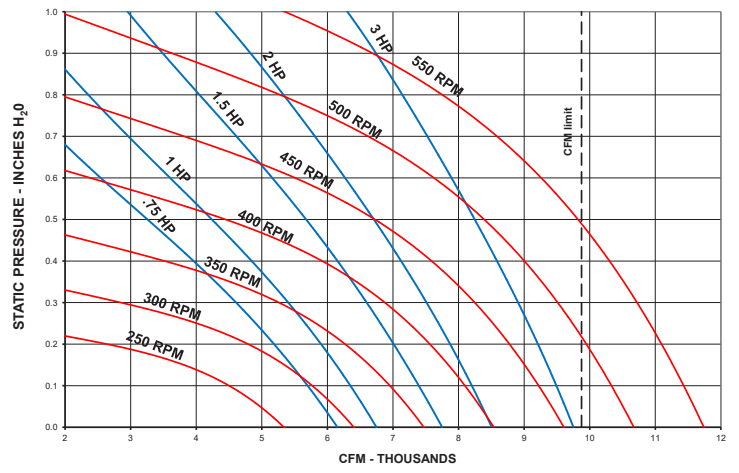

ID/IS601 w/ WS144 - Airflow Data

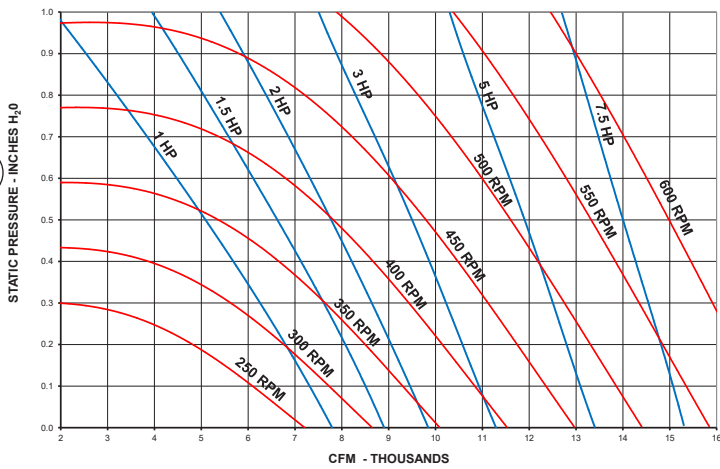

ID/IS/IUP701 w/ WS144 - Airflow Data

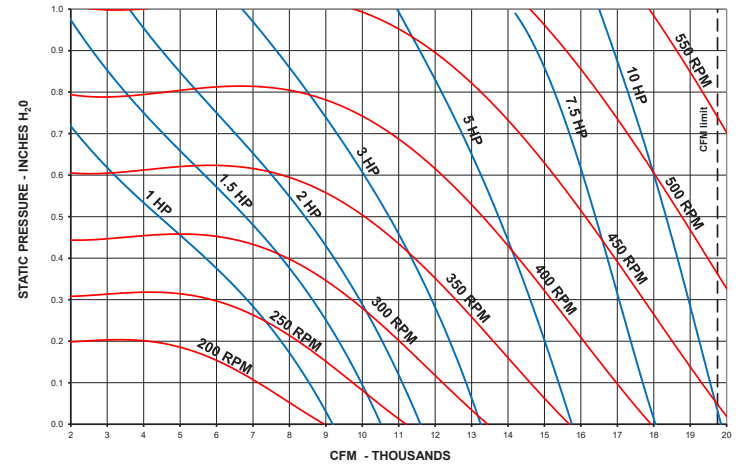

ID/IS/IUP800 w/ WS844 - Airflow Data

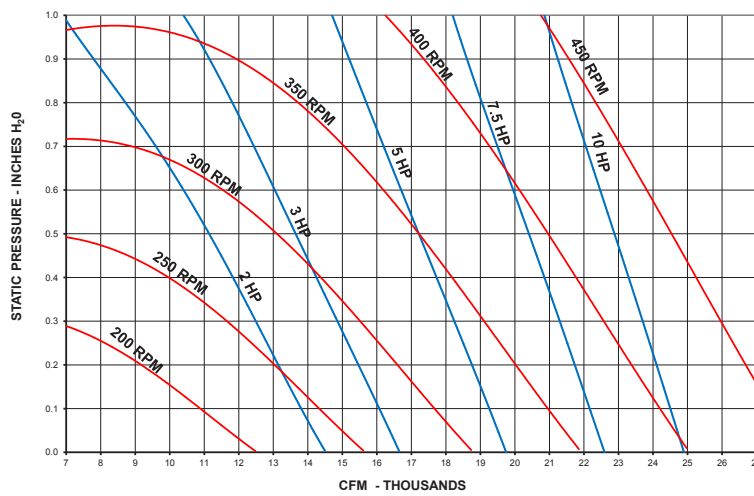

# Engineering Data

Dimensional information for the Aerocool Industrial Coolers with 12" media, 8" media and the Ultra-Efficient 4x4 media.

## Single Inlet Discharge 500 Series

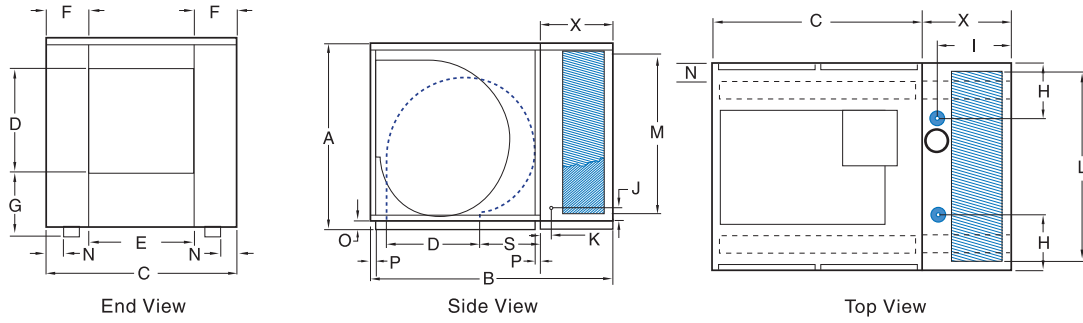

## Dual Inlet Discharge 601, 701 & 800 Series

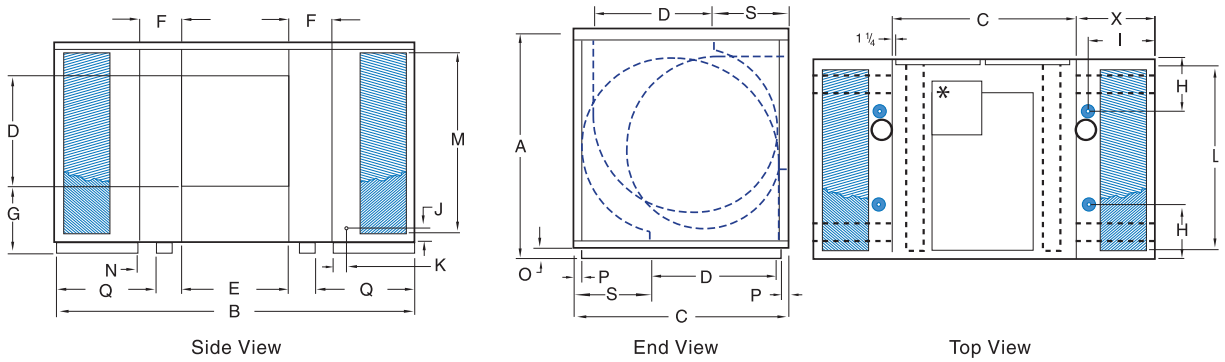

## 12" Standard Media

Model Number	Cabinet Dimensions (Inches)																				Ship Weight	Oper. Weight	Blower Wheel Dia x Width	Blower Pulley Pitch Diameter			
	H	W	D	Wet Cab	Duct Opening					Drain Loc.		Water Svc.		Media		Skid Location				Belts							
	A	B	C	X	D	E	S	F	G	H	I	J	K	L	M	N	O	P	Q	QTY					SIDE	DOWN	UP
ID500	51 5/8	70	49	21	27	26 7/8	17 1/4	11 1/8	N/A	13	17 3/8	5	3 7/16	48	44 1/2	4 1/2	2 1/2	1 1/8	N/A	1	A80	A77	N/A	485	565	24 X 24	13" Single
IS500	51 5/8	70	49	21	27	26 7/8	N/A	11 1/8	16 3/4	13	17 3/8	5	3 7/16	48	44 1/2	4 1/2	2 1/2	1 1/8	N/A	1	A80	A77	N/A	485	565	24 X 24	13" Single
ID601	51 5/8	91	49	21	27	26 7/8	17 1/4	11 1/8	N/A	13	17 3/8	5	3 7/16	48	44 1/2	1 7/8	2 1/2	1 1/8	25 1/4	2	A98	A98	N/A	645	774	24 x 24	18" Dual
IS601	51 5/8	91	49	21	27	26 7/8	N/A	11 1/8	19 3/4	13	17 3/8	5	3 7/16	48	44 1/2	1 7/8	2 1/2	1 1/8	25 1/4	2	A98	A98	N/A	645	774	24 x 24	18" Dual
ID/IS 701	51 5/8	91	49	21	31 3/4	31 3/4	14 7/8	8 5/8	17 3/8	13	17 3/8	5	3 7/16	48	44 1/2	1 7/8	2 1/2	1 5/8	22 7/8	2	A90	A85	N/A	668	830	28 x 28	18" Dual
IUP 701	51 5/8	91	49	21	31 3/4	31 3/4	13 3/4	8 5/8	N/A	13	17 3/8	5	3 7/16	48	44 1/2	1 7/8	2 1/2	1 5/8	22 7/8	2	N/A	N/A	A90	668	830	28 x 28	18" Dual
ID/IS/IUP 800	61 1/2	103 7/8	62	21	34	34	22 3/4	14	25 1/4	13	17 3/8	5	3 1/2	60	54 1/2	6	2 1/2	1 5/8	26 5/8	2	A105	A90	A108	920	1,160	30 x 28	18" Dual

## 8" Standard Media & 4x4 Media

Model Number	Cabinet Dimensions (Inches)																				Ship Weight	Oper. Weight	Blower Wheel Dia x Width	Blower Pulley Pitch Diameter			
	H	W	D	Wet Cab	Duct Opening					Drain Loc.		Water Svc.		Media		Skid Location				Belts							
	A	B	C	X	D	E	S	F	G	H	I	J	K	L	M	N	O	P	Q	QTY					SIDE	DOWN	UP
ID500	51 5/8	66	49	17	27	26 7/8	17 1/4	11 1/8	N/A	13	13 3/8	5	3 1/2	48	44 1/2	4 1/2	2 1/2	1 1/8	N/A	1	A80	A77	N/A	460	538	24 X 24	13" Single
IS500	51 5/8	66	49	17	27	26 7/8	N/A	11 1/8	16 3/4	13	13 3/8	5	3 1/2	48	44 1/2	4 1/2	2 1/2	1 1/8	N/A	1	A80	A77	N/A	460	538	24 X 24	13" Single
ID601	51 5/8	83	49	17	27	26 7/8	17 1/4	11 1/8	N/A	13	13 3/8	5	3 1/2	48	44 1/2	1 7/8	2 1/2	1 1/8	21 1/4	2	A98	A98	N/A	595	719	24 x 24	18" Dual
IS601	51 5/8	83	49	17	27	26 7/8	N/A	11 1/8	19 3/4	13	13 3/8	5	3 1/2	48	44 1/2	1 7/8	2 1/2	1 1/8	21 1/4	2	A98	A98	N/A	595	719	24 x 24	18" Dual
ID/IS 701	51 5/8	83	49	17	31 3/4	31 3/4	14 7/8	8 5/8	17 3/8	13	13 3/8	5	3 1/2	48	44 1/2	1 7/8	2 1/2	1 5/8	18 7/8	2	A90	A85	N/A	619	775	28 x 28	18" Dual
IUP 701	51 5/8	83	49	17	31 3/4	31 3/4	13 3/4	8 5/8	N/A	13	13 3/8	5	3 1/2	48	44 1/2	1 7/8	2 1/2	1 5/8	18 7/8	2	N/A	N/A	A90	619	775	28 x 28	18" Dual
ID/IS/IUP 800	61 1/2	95	62	17	34	34	22 3/4	14	25 1/4	13	17 3/8	5	3 1/2	60	54 1/2	6	2 1/2	1 5/8	22 5/8	2	A105	A90	A108	880	1,070	30 x 28	18" Dual

AEROCOOL® Evaporative Coolers and components are designed and tested in accordance with one or more of the following standards or agencies: **AIR DELIVERY** - data published derived from tests conducted in accordance with A.M.C.A. (Air Movement and Control Assoc.) standard 210. **EVAPORATIVE MEDIA** - Specially corrugated cellulose material, impregnated with insoluble antirrot salts and rigidifying saturants. **SEALANT** - water immersion per ASTM D870. **FLEXIBILITY** - per ASTM D756. **CORROSION RESISTANCE** - per ASTM B117. **PENCIL HARDNESS** - per ASTM D3363. **IMPACT RESISTANCE** - per D2794. **FLEXIBILITY** - per ASTM D522. **SURFACE BURNING CHARACTERISTICS** of building materials (best rating) per UL 723 and ASTM E-84. **SINGLE PHASE MOTOR** tested under UL standard #547 for locked rotor and heat rise protection. **BLOWER WHEEL** - balanced in accordance with ISO 1940 and A.N.S.I. standard S2.19, quality grade G6.3.

# Sheave & Motor Data

Sheave and motor combinations, pump and belt options.

## Sheave Selection

All sheaves listed are adjustable to meet the blower speed RPM requirements for your application. Using the model number combined with the motor horsepower and blower RPM, use this chart to locate the corresponding part number in the far right column.

## Motor Selection

Motors of varying voltages and identical horsepower may have different motor shaft sizes. Be certain the motor shaft diameter and motor sheave bore size are the same size.

All single phase motors are thermally protected and do not require starting devices.

Motors which are 3 Phase 1 HP and greater, are high efficiency motors that meet or exceed U.S. E.I.S.A. (Energy Independence & Security Act)

## Sheave Selection

Model Number	Motor H.P.	Bore	Blower RPM - Sheave Turns Open						PMI Part
			5	4	3	2	1	0	
ID/IS 500	3/4, 1, 1 1/2, 2	5/8	252	279	305	332	358	385	S1
ID/IS 500	1, 1 1/2, 2	7/8	252	279	305	332	358	385	S1A
ID/IS 500	3/4, 1, 1 1/2, 2	5/8	318	345	372	398	425	451	S2
ID/IS 500	1, 1 1/2, 2	7/8	318	345	372	398	425	451	S2A
ID/IS 500	3/4, 1, 1 1/2, 2	5/8	372	398	425	451	478	504	S3
ID/IS 500	1, 1 1/2, 2	7/8	372	398	425	451	478	504	S3A
ID/IS 500	1, 1 1/2, 2	5/8	451	478	504	531	557	584	S4A
ID/IS 500	1, 1 1/2, 2	7/8	451	478	504	531	557	584	S4
ID/IS 500	3	1 1/8	372	398	425	451	478	504	S3B
ID/IS 500	3	1 1/8	451	478	504	531	557	584	S4B
ID/IS 601	1, 1 1/2, 2	5/8	249	268	288	307	326	345	S6A
ID/IS 601	1, 1 1/2, 2	7/8	249	268	288	307	326	345	S6
ID/IS 601	1, 1 1/2, 2	5/8	326	345	364	383	403	422	S8A
ID/IS 601	1, 1 1/2, 2	7/8	326	345	364	383	403	422	S8B
ID/IS 601	1, 1 1/2, 2	5/8	383	403	422	441	461	479	S9A
ID/IS 601	1, 1 1/2, 2	7/8	403	422	441	460	479	498	S9B
ID/IS 601	3	1 1/8	326	345	364	383	403	422	S8
ID/IS 601	3, 5	1 1/8	403	422	441	460	479	498	S9
ID/IS 601	5	1 1/8	450	470	489	508	527	546	S10A
ID/IS 601	7 1/2	1 3/8	450	470	489	508	527	546	S10
ID/IS 601	7 1/2	1 3/8	498	518	537	556	575	594	S12
ID/IS/IUP 701	1, 1 1/2, 2	5/8	192	211	230	249	268	288	S5A
ID/IS/IUP 701	1, 1 1/2, 2	7/8	192	211	230	249	268	288	S5
ID/IS/IUP 701	1, 1 1/2, 2	5/8	249	268	288	307	326	345	S6A
ID/IS/IUP 701	1, 1 1/2, 2	7/8	249	268	288	307	326	345	S6
ID/IS/IUP 701	1, 1 1/2, 2	5/8	326	345	364	383	403	422	S8A
ID/IS/IUP 701	1, 1 1/2, 2	7/8	326	345	364	383	403	422	S8B
ID/IS/IUP 701	3	1 1/8	249	268	288	307	326	345	S7
ID/IS/IUP 701	3, 5	1 1/8	326	345	364	383	403	422	S8
ID/IS/IUP 701	3, 5	1 1/8	403	422	441	460	479	498	S9
ID/IS/IUP 701	7 1/2	1 3/8	355	374	393	413	432	441	S8C
ID/IS/IUP 701	7 1/2, 10	1 3/8	403	422	441	460	479	498	S9C
ID/IS/IUP 701	10	1 3/8	450	470	489	508	527	546	S10
ID/IS/IUP 800	2	5/8	192	211	230	249	268	288	S5A
ID/IS/IUP 800	2	7/8	192	211	230	249	268	288	S5
ID/IS/IUP 800	2	5/8	249	268	288	307	326	345	S6A
ID/IS/IUP 800	2	7/8	249	268	288	307	326	345	S6
ID/IS/IUP 800	2	5/8	326	345	364	383	403	422	S8A
ID/IS/IUP 800	2	7/8	326	345	364	383	403	422	S8B
ID/IS/IUP 800	3, 5	1 1/8	249	268	288	307	326	345	S7
ID/IS/IUP 800	3, 5	1 1/8	326	345	364	383	403	422	S8
ID/IS/IUP 800	7 1/2, 10	1 3/8	355	374	393	413	432	441	S8C
ID/IS/IUP 800	10	1 3/8	403	422	441	460	479	498	S9C

## Technical Motor Specifications

Model No.	H.P.	Therm. Pro	Phase	Volt	Amperage	Base	Frame	Shaft Dia.
M180	3/4 - 2 spd.	X	1	120	10.5-5.8	Resilient	56	5/8
M161	3/4	X	1	120 / 208-240	10.6 / 5.3	Resilient	56	5/8
M163	3/4		3	208-240 / 480	2.7-2.8 / 1.4	Resilient	56	5/8
M181	1 - 2 spd.	X	1	120	12.4	Resilient	56	5/8
M165	1	X	1	120 / 208-240	14.0 / 7.0	Resilient	56	5/8
M166	1		3	* 240 / 480	3.2 / 1.6	Rigid	143T	7/8
M167	1		3	200	3.6	Rigid	143T	7/8
M168	1 - 2 spd.	X	1	240	7.2	Resilient	56	5/8
M169	1 1/2	X	1	120 / 208-240	18 / 9.3-9	Resilient	56H	5/8
M170	1 1/2		3	* 240 / 480	4.6 / 2.4	Rigid	145T	7/8
M171	1 1/2		3	200	5.1	Rigid	145T	7/8
*M172	2	X	1	120 / 208-240	21 / 11.3-10.5	Resilient	56H	5/8
M173	2		3	* 240 / 480	6.0 / 3.0	Rigid	145T	7/8
M174	2		3	200	6.6	Rigid	145T	7/8
M176	3		3	* 240 / 480	8.0 / 4.0	Rigid	182T	1 1/8
M177	3		3	200	10.1	Rigid	182T	1 1/8
M178	5		3	208-240 / 480	13.6-12.6 / 6.3	Rigid	184T	1 1/8
M179	5		3	200	15.6	Rigid	184T	1 1/8
M182	7 1/2		3	* 240 / 480	18.6 / 9.3	Rigid	213T	1 3/8
M183	10		3	* 240 / 480	24.4 / 12.2	Rigid	215T	1 3/8

\* Can be suitable for use with 208 Voltage

## Pump Specifications

Pump Model	Volts	Amps	Watts	GPM at 5' Head
PK60LA	120	1.7	105	7.3
PK62LA	240	1.1	105	7.3

## Alternative Belt Kits

Unit Number	Motor H.P.	Kit Number
IS 500	3	Belt A83
ID 500	3	Belt A79

Note: ID/IS 500 .8" static pressure and higher requires belt change to above



WARNING: This product can expose you to chemicals including Lead, which is known to the State of California to cause cancer and birth defects or other reproductive harm. For more information go to [www.P65Warnings.ca.gov](http://www.P65Warnings.ca.gov)



# Value & Commitment

Phoenix Manufacturing, Inc. (PMI) is a designer, manufacturer, and distributor that primarily produces evaporative cooling products designed for the comfort of the home or business.

Values at PMI begin with our employees, customers, and suppliers. We strive each day to treat those involved with PMI with respect while performing our duties with integrity. We put a premium on those values to best serve our industry in a manner that will deliver quality in everything we do. The phone call, the e-mail, the meetings, along with the products and the service, is designed to deliver these values as no one else does and to do it consistently each day.



Phoenix Manufacturing Inc.  
3655 East Roeser Road  
Phoenix, Arizona 85040

Phone: 602-437-1034  
Fax: 602-437-4833  
[phoenixmanufacturing.com](http://phoenixmanufacturing.com)